

3.5 DIA Miniature Jack

(03-945) Series

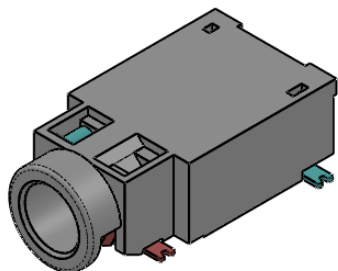

03-945A0-66BKA

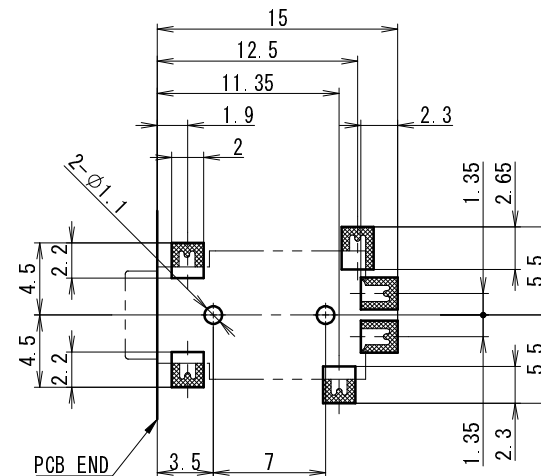
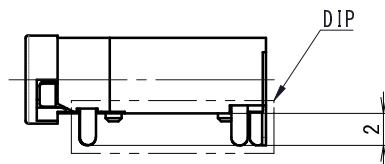
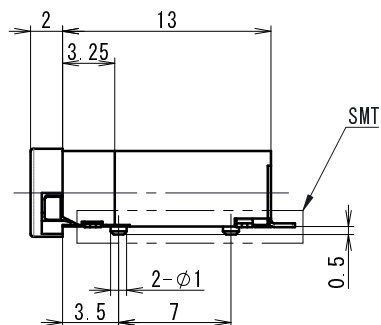
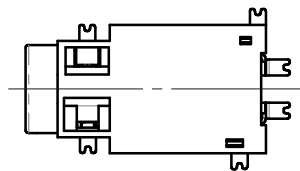
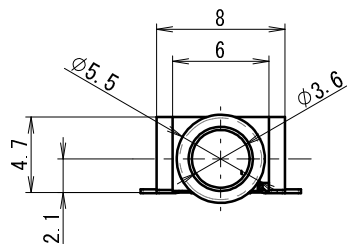

PCB Layout (SMT)
(Top View)

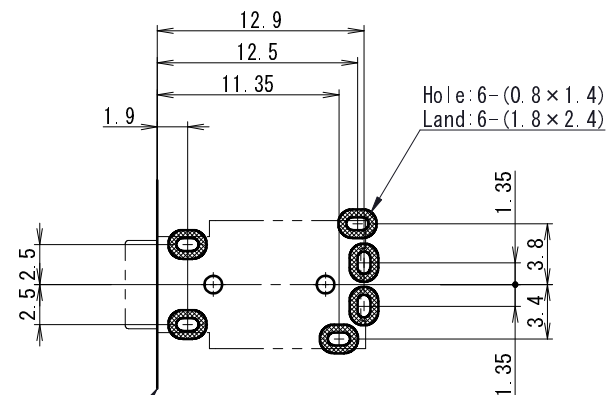

PCB Layout (DIP)
(Top View)

※The back same dimension

Part No.	03-945A0-66BKA	03-945C0-66BKA
Schematic		
Mounting style	SMT	DIP